



Your Summer.
Simplified.

ShoreStation®

Summer Fun Central.

Summertime is your time. Share your summer story, and ShoreStation might just make you a winner!

Find out how at ShoreStationSimple.com



The ShoreStation Difference

Better Performance and Design

All you want to do is get in and get out... and look like a pro doing it. That's exactly why ShoreStation's time-tested lifting mechanisms, engineered for easy docking and launching have earned the trust of thousands of boat owners. The "V" shape platform allows for operation in shallow water and provides easier centering while innovative technologies like hydraulic lift systems have increased speed performance and remote controls make operation effortless.

Customizable

Different users have different needs and that's why ShoreStation offers a complete line of options.

Built to be Durable & Dependable

One of the most important duties of a boat lift is to protect your boat when it's out of its element. ShoreStation does it with low maintenance aluminum construction, motor stops, aluminum/poly UltraBunks, stainless steel & brass fasteners, and GAR-MAX bushings. In addition when in the "up" position, there are no moving parts left in the water which minimizes corrosion. Everything is corrosion resistant, protecting your boat for years to come.

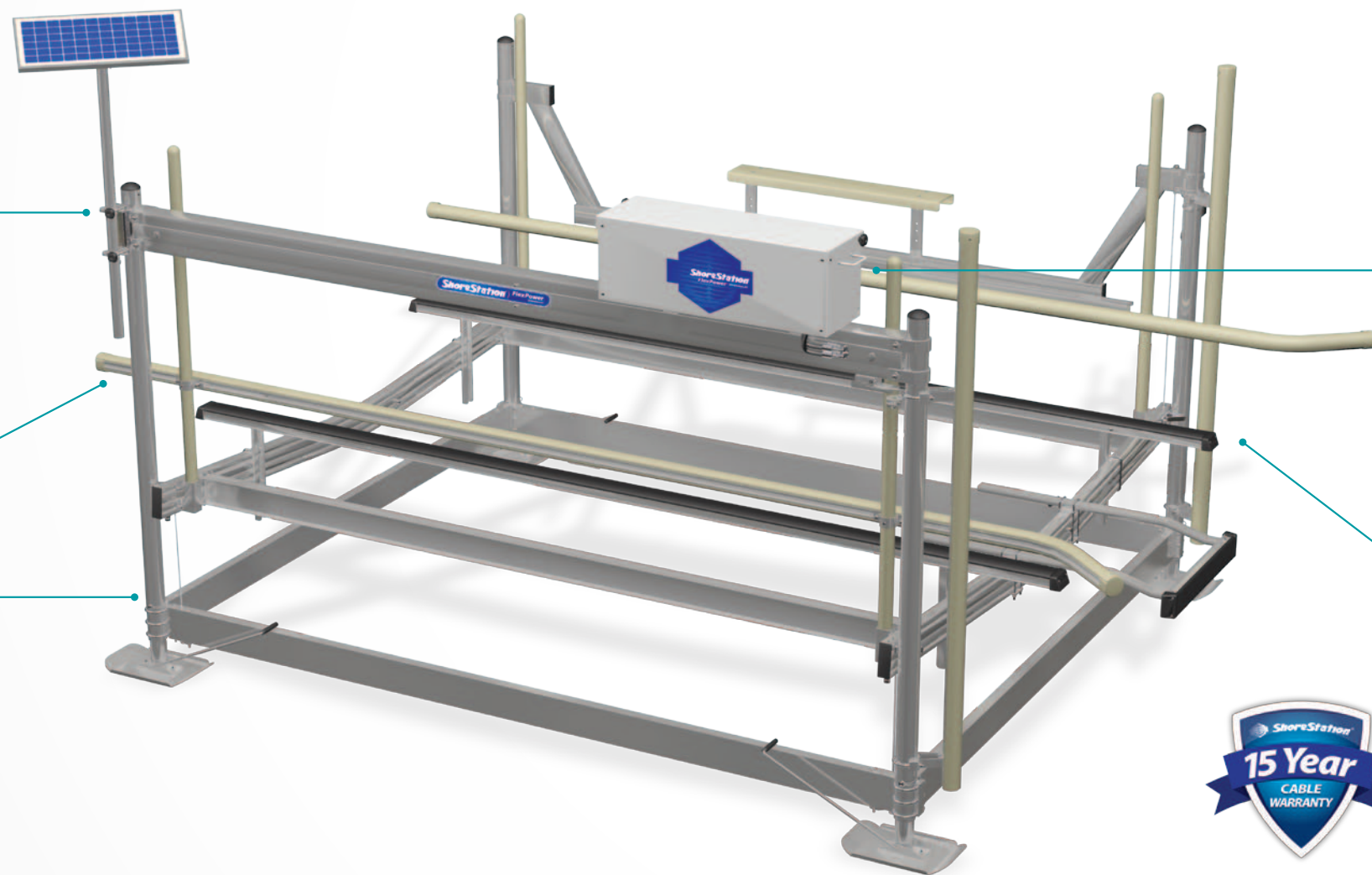

Features Comparison

	ShoreStation® Hydraulic	ShoreStation® Electric	Friction Wheel	After-market Direct Drive*
Wireless Operation	Yes	Yes	No	Yes
Integrated Design	Yes	Yes	No	No
Fully enclosed protective cover	Yes	Yes	No	No
24 volt DC Option	No	Yes	No	Yes
Adjustable Upper Limit	Standard	Standard	No	No
Back Wind Sensor	Not required	Standard	No	No
Emergency manual operation	No	Yes	Yes	Yes
Auto-Up Feature	Yes	No	No	No
Remote switch for optional lights	Yes (2)	Yes (2)	No	Yes

*Aftermarket drive application may void ShoreStation factory warranty.



Speed Matters ShoreStation Boat Lifts will get you on and off the water in a hurry!

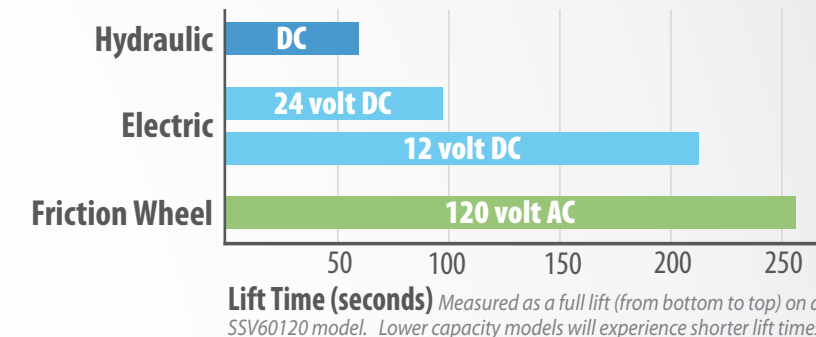

5 Styles of Lifts to Raise and Lower Boats:



Hydraulic - Secures your boat 5 times faster than traditional lifts. Giving you confidence to safely land and secure your boat in less than ideal conditions. Available in 4000 lb. to 15,000 lb. capacity vertical lifts. See page 4 & 5 for more details.

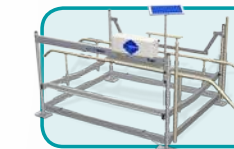

Pontoon Lifts - Available in 3000 lb. to 10,000 lb. capacities in hydraulic, electric, or manual. We offer 4 pontoon support options for the best fit. See page 6 & 7 for more details.



Electric - Available in 2000 lb. to 6000 lb. capacity vertical lifts. They feature our time tested ShoreStation winch system with an integrated drive motor, wireless remote controls, and upper limit and back wind controls to prevent damage. See page 8 & 9 for more details.



Manual - Available in 2000 lb. to 5000 lb. capacities in aluminum vertical featuring our time tested ShoreStation winch system. Manual wheel-driven lifts are the most economical and incorporate a geared winch for easier lifting. See page 10 & 11 for more details.



PWC Lifts - Available in 800 lb. to 1500 lb. capacities. Your choice of dock-mount or free-standing models for one or two machines. See page 12 & 13 for more details.

FlexPower® Versatility

ShoreStation broke the mold when it engineered its FlexPower® system, resulting in one of the fastest lifts on the market. DC battery power is the brawn behind FlexPower®, purposely chosen for its safety and superior performance over AC in marine environments.

With FlexPower®, the battery acts as a buffer between the power supply and lift. FlexPower® delivers maximum and constant power to the motor for fast lift times, ensuring years of trouble-free operation.

FlexPower® also removes the worry of battery drain and maintenance. Choose from our totally automatic power supplies - solar or battery tender. These charging systems keep the battery at peak power taking the hassle out of battery maintenance.

UltraBunks for the Perfect Fit

Maintenance and corrosion free poly/aluminum UltraBunks are ultra-durable and ultra strong, yet provide the optimal degree of flex to conform to the boat's hull. The fully adjustable pivoting brackets allow it to perfectly fit any boat. No wood to rot, no carpet to tear!

ShoreStation® | At the forefront of shorefront since 1959

Models and specifications subject to change. Visit shorestation.com for the latest updates. Some models are shown with optional equipment.



HYDRAULIC FEATURES & BENEFITS

- 1 **Quickly Secures Boat** - When you have a Hydraulic Lift, there's no need to worry about wind and waves getting in your way. This lift is the fastest on the market and will give you confidence to safely land and secure your boat in less than ideal conditions.
- 2 **Maximum Protection for Your Boat and Lift** - With cables that are pulled instead of wound, this system is designed to eliminate cable fatigue issues and safeguard against critical failure. In addition, our hydraulics are pressure regulated, so they stall before lifting potentially damaging loads, giving you peace of mind that your precious cargo is safe.
- 3 **Reliable by Design** - With so many variables in the marine environment, deliberate design is crucial. The "high and dry" construction of the hydraulic lift keeps your essential hydraulic and electronic components above the water, minimizing their exposure to moisture and humidity. In addition, the solar-powered, DC operating system eliminates the need for an AC circuit on the dock, providing safety and superior performance on command. This is a lift you can rely on, day after day.



The best cable warranty on the market!
All ShoreStation® Hydraulic and Electric boat lifts are backed by the best warranty in the industry. Our unique design significantly reduces cable stress and keeps your lift working properly for years to come.

Simple and swift, from launch to lift

SOLAR BATTERY CHARGING SYSTEM
Power the lift with clean, free solar power. The speedy 20 watt charger features a solar regulator to prevent battery drain and protect your battery from permanent damage caused by overcharging.

HYDRAULIC POWER PACK
The corrosion free powder-painted aluminum box protects the hydraulic pump and battery from the elements. Featuring a hinged lid for easy access, it mounts securely on the lift tube or can be placed on the dock with optional hydraulic hose extension kits.

DOCKSIDE UP/DOWN OPERATION
Misplaced your remote? Use the convenient up/down switch with key lock-out mounted directly on your lift.

DROP SIDE WITH BOARDING STEP
Provides safe and easy access to your boat. The foot-friendly, sand-beige aluminum step mounts to drop side lift tube.

ULTRABUNKS
Pivoting maintenance free aluminum/poly bunks are mounted on sturdy support channels to shoulder the load.

WIRELESS REMOTE
Raise and lower your ShoreStation® Hydraulic lift with this handy remote transmitter. Two come standard.

SSV60120HS

See page 18 for a complete list of models and specifications.

ShoreStation® | At the forefront of shorefront since 1959

Models and specifications subject to change. Visit shorestation.com for the latest updates. Some models are shown with optional equipment. 5

When it comes to your time on the water, Speed, Safety, and Reliability aren't luxuries, they're necessities.

ShoreStation Hydraulic Lifts are the fastest on the market, easy to operate, and dependable. Our thoughtful design makes your boating simple and swift, from launch to lift. When seconds count, turn to ShoreStation.



ShoreStation Pontoon Lifts
 have been updated to fit
 today's larger, heavier
 pontoons. In addition to the
 new sizes and better fit, these
 lifts have the same great
 quality as our standard line.

PONTOON LIFTS

FEATURES & BENEFITS



3 options to lift your pontoon

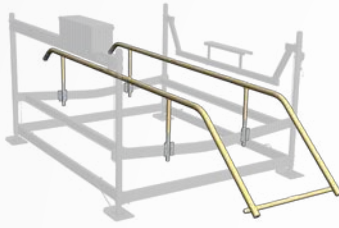

TOONRAIL
 The 3-in-1 under-deck lift support with integrated motor stop and load guides is economical and maintenance free. The contoured poly-covered tubes both guide the pontoon into the lift and support it by simply lifting under the deck inside the outer tubes.



PONTON LOG RACK
 The double UltraBunks and full length GlideRail load guides cradle and channel the outer "logs" perfectly every time. The unique kit is designed to work well on both tritoons and standard pontoons with tubes up to 29".



PONTON/TRITOON DOUBLE BUNK OPTIONS
 Available with 2 or 3 tube supports that adjust to fit any pontoon. The premium poly-aluminum UltraBunks are often combined with under-deck post load guides to reduce lift width requirements.
 *Support brackets for Plank Center Lift also available



The best cable warranty on the market!
 All ShoreStation® Hydraulic and Electric boat lifts are backed by the best warranty in the industry. Our unique design significantly reduces cable stress and keeps your lift working properly for years to come.

Go from elevated to entertaining with the combined **strength and versatility** of Pontoon lifts

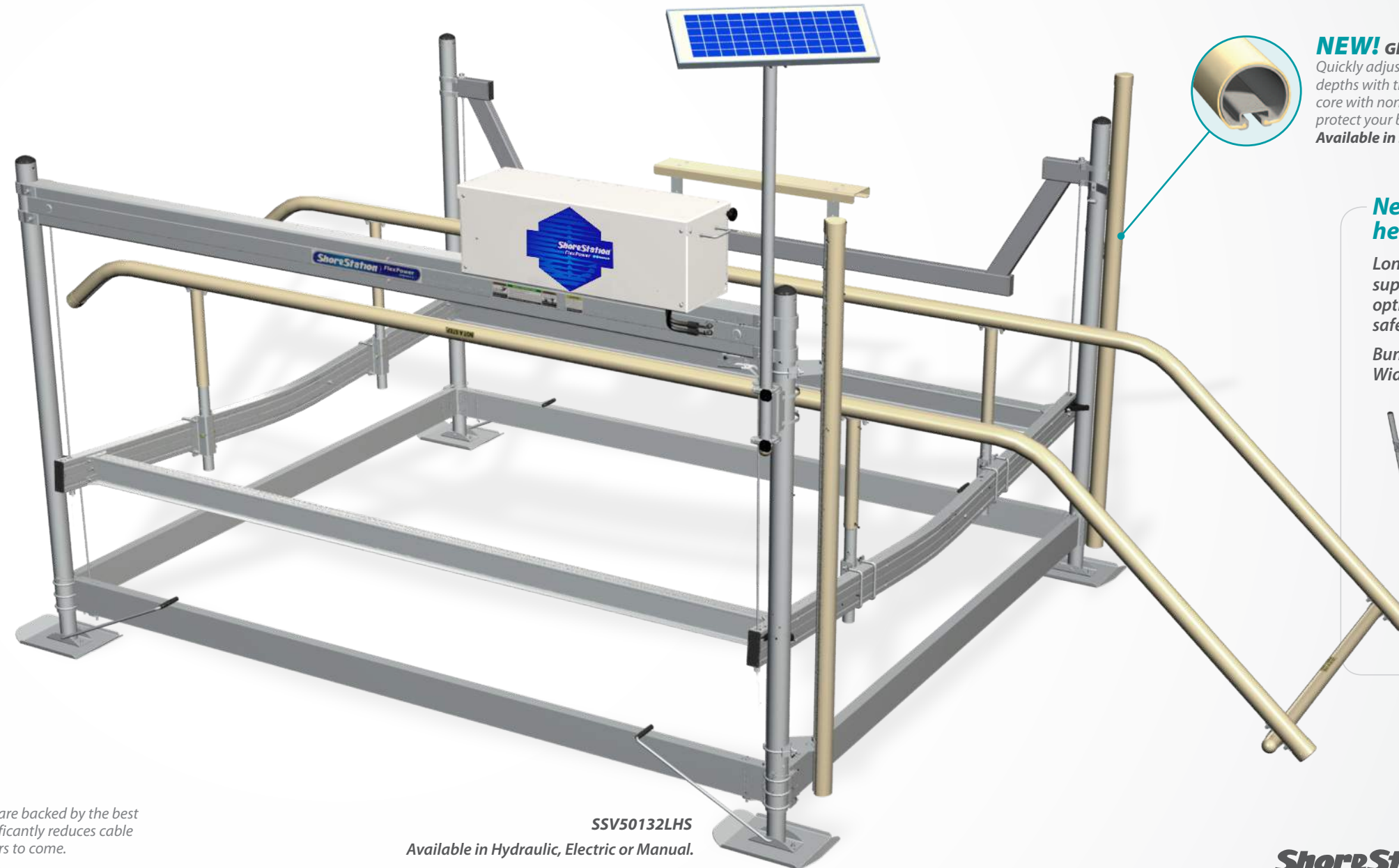

NEW! GlideRail/GlidePole CONSTRUCTION
 Quickly adjusts for various boat hulls and water depths with the NEW t-slot design. The durable aluminum core with non-marring UV stable poly sheath are sure to protect your boat while absorbing repeated shocks.
 Available in sand beige.

New model to fit today's larger, heavier tritoons.

Longer bunks and greater width provide superior support for your tritoon. Add the optional load guides for an added measure of safety and perfect positioning time after time.

Bunk Length - 15'
 Width - 11'



SSV70132DW

SSV50132LHS
 Available in Hydraulic, Electric or Manual.

See page 18 for a complete list of models and specifications.

ShoreStation® | At the forefront of shorefront since 1959



ELECTRIC

FEATURES & BENEFITS

- 1 Simple, Integrated Design** - The time-tested ShoreStation winch has a direct drive motor that is integrated and enclosed reducing exposure to the outdoor environment. The rugged, galvanized steel winch frame reduces deflections and maintains alignment of internal components.
- 2 Lift System Protection** - Electric systems feature a back-wind sensor and upper limit switch protecting the lift from damage. The adjustable upper limit switch stops the platform at any desired height for added protection.
- 3 Reliable DC Power** - The solar-powered, DC operating system eliminates the need for an AC circuit on the dock, providing safety and superior performance on command.

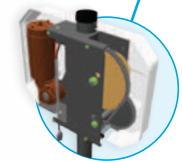

The stylish, corrosion-free cover protects the motor from the elements while giving the unit a clean, finished appearance.

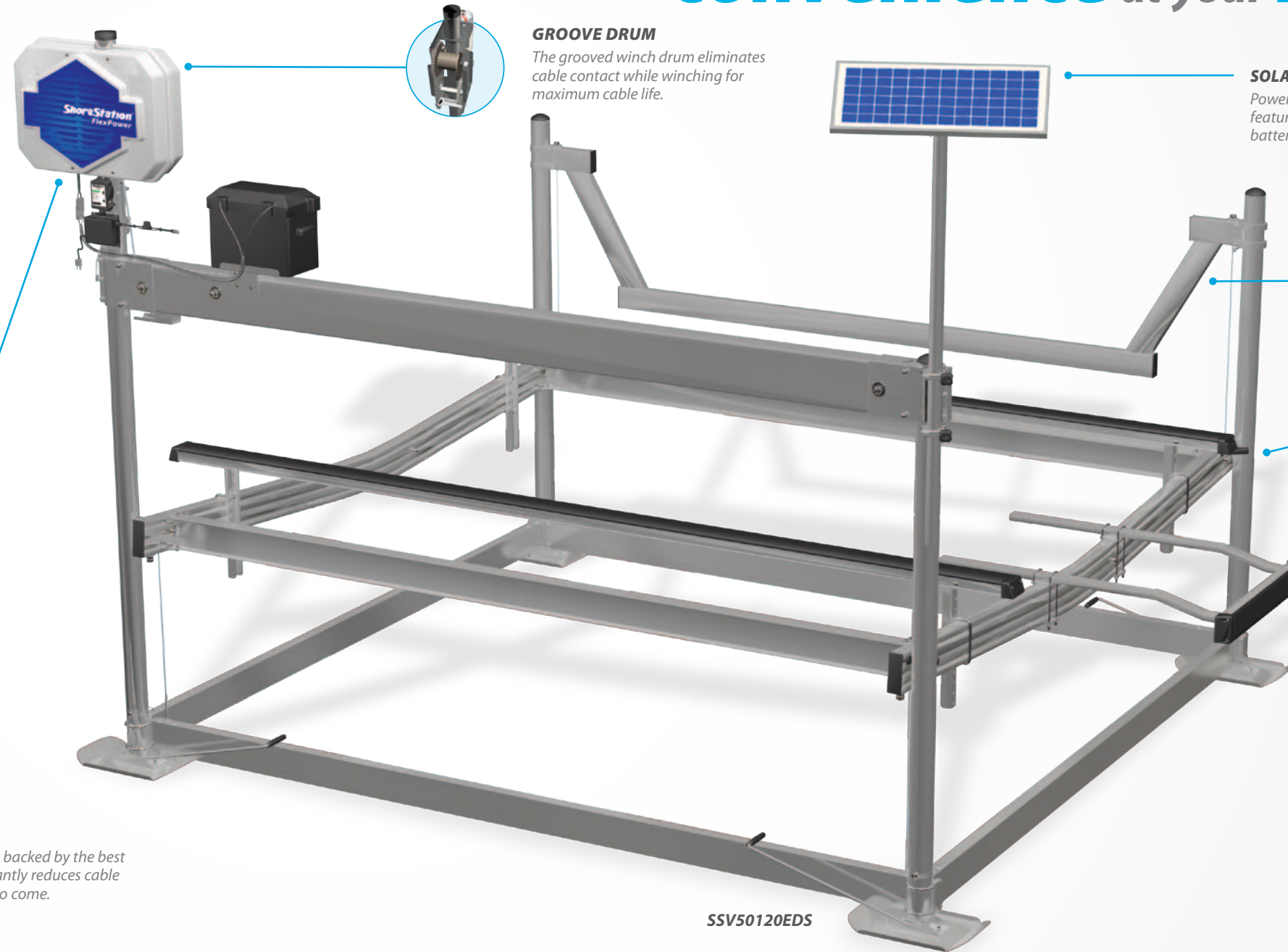

From covered to cruising, Electric models secure **convenience** at your **fingertips**

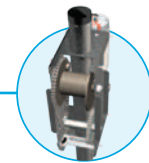

GROOVE DRUM
The grooved winch drum eliminates cable contact while winching for maximum cable life.

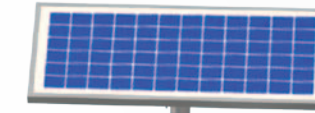

SOLAR BATTERY CHARGING SYSTEM
Power the lift with clean, free solar power. The speedy 20 watt charger features a solar regulator to prevent battery drain and protect your battery from permanent damage caused by overcharging.

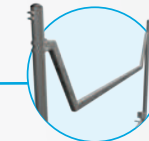

DROP SIDE
The unique Drop Side provides easy access to your boat.



ULTRABUNKS
Pivoting maintenance free aluminum/poly bunks are mounted on sturdy support channels to shoulder the load.



DOCKSIDE UP/DOWN OPERATION
Misplaced your remote? Use the convenient up/down switch with key lock-out mounted directly on your lift.



WIRELESS REMOTE
Raise and lower your ShoreStation® Electric lift with this handy remote transmitter. Two come standard.



The best cable warranty on the market!
All ShoreStation® Hydraulic and Electric boat lifts are backed by the best warranty in the industry. Our unique design significantly reduces cable stress and keeps your lift working properly for years to come.

SSV50120EDS

Available on lifts from 2000 to 6000 pounds. See page 18 for a complete list of models and specifications.

ShoreStation® | At the forefront of shorefront since 1959



Manual Aluminum models
 for 2000 lb. fishing boats,
 to the largest – for 5000 lb.
 cruisers, you'll get
 years of convenient,
 dependable operation.

MANUAL ALUMINUM FEATURES & BENEFITS

- 1 **Time-tested ShoreStation Winch** - Has earned the trust of thousands of boat owners with decades of proven history. It offers smoother lifting and dependability far superior to any ordinary winch. The Wheel Lock Mechanism safety feature is spring activated, preventing the platform from being raised too high.
- 2 **Superior Design** - The "V" shape of the platform allows for operation in shallow water and provides easier centering. It is raised and lowered vertically to eliminate torque that would fatigue and weaken the lift. In the "up" position, there are no moving parts left in the water which minimizes corrosion.
- 3 **Durable Low Maintenance Construction** - Everything is designed for years of dependable service: aluminum construction, stainless steel cables, poly/aluminum UltraBunks, sealed roller bearings in winch tube pulleys, stainless steel/brass fasteners, GAR-MAX bushings. The bolt-together aluminum construction provides superior environmental endurance and eliminates the need for aluminum welds while adding to the strength and stability of the lift.



SSAC2 & SSDC2 (Optional)
 Tired of cranking the wheel of your manual lift? This simple rub-wheel motor drives the wheel to raise the lift.



SSV40120MS

From winched to water, manual lifts offer low maintenance, time tested dependability



ULTRABUNKS
 Pivoting maintenance free aluminum/poly bunks are mounted on sturdy support channels to shoulder the load.



MOTOR STOP
 For an added measure of safety and perfect positioning time after time.

PROPRIETARY LIFTING PRINCIPLE
 Our level lifting equalizes the load across the entire structure, reducing stress on the lift and it's components. Unlike "v-frame" lifts, our horizontal lift tube creates two lifting points distributing the weight for smooth trouble-free operation.

See page 18 for a complete list of models and specifications.

ShoreStation® | At the forefront of shorefront since 1959



ShoreStation PWC lifts
 For any personal watercraft and nearly all waterfronts – up to 1500 lb capacity and 5'6" deep!

Available in *four* different styles...

Vertical



SSV1564ED



SSV1564M

1500 lb. Capacity – Aluminum Vertical

Our new vertical lift design can handle deeper water and your largest crafts - up to 5'6" deep and 1500 lbs.

- Same great quality as our larger lifts with ShoreStation's time-tested vertical lift system and low maintenance aluminum construction.
- Available in manual or electric
- Comes standard with 2 wireless remote to raise & lower your lift.
- "V" cradle design for shallow water operation.
- Self-adjusting pivoting bunks cradle watercraft's hull

Cantilever



SS853



SS10621

800 lb. Capacity - Steel Cantilever

With 800 lb. capacity this powder-coated steel PWC lifts may be economical, but that doesn't mean it isn't packed with features.

- Cantilever platform and brake winch provide safe up-down operation.
- Self-adjusting, pivoting bunks cradle the watercraft's hull, providing better support and evenly distributing weight.
- Corrosion resistant, glass-filled thermoplastic pulleys and pulley placement ensure minimal wear on moving parts and increased durability.
- Also available with 4 legs.

1000 lb. Capacity – Aluminum Cantilever

This aluminum constructed cantilever style PWC lift can handle watercrafts up to 1000 lb.

- 30" operator's wheel and brake winch provides safe, smooth operation.
- Self-adjusting, pivoting bunks cradle the watercraft's hull.
- Heavy-duty aluminum frame and posts for larger watercrafts.
- Also available with 4 legs for deeper water, electric drive winch, optional canopy, or aluminum/poly UltraBunks.

Dock Mount



SS1053

1000 lb. Capacity

Aluminum Dock Mount lifts feature a space saving footprint and convenient boarding access from the dock.

- Mounts to ShoreStation Classic Sectional Dock, ShoreBridge or most standard docks.
- Geared brake winch with nylon strap and level-lift cable provide safe, unbinding up-down operation.
- Optional electric drive winch.
- Fully-carpeted, 2' x 6' bunks provide solid support.

Cantilever Two-Place



SSD10521

1000 lb. Capacity Each

This is no ordinary boat lift. The two-place Free-standing PWC lift has space for two 1000 lb. machines.

- Independently operated lift platforms and operator's wheel with brake winches for smooth operation.
- Also available with optional electric drive winch.
- Designed for years of dependable service with corrosion resistant aluminum construction, thermoplastic pulleys and stainless steel bearing surfaces.
- Add the optional canopy and aluminum/poly UltraBunks.

See page 19 for a complete list of models and specifications.



ShoreScreen *From covered to uncovered in seconds. Protect your boat with this high-tech screen.*

The Ultimate in Boat Protection - Protect your boat from damaging UV rays, and create a barrier against wind-blown debris, insects and birds to ensure your boat stays in showroom condition. No more hassling with traditional heavy boat covers and snaps.

Fast, Trouble-free Operation - Two drive motors positioned on opposite corners roll all four screens simultaneously without complicated cables or pulleys. The adjustable limit stop allows the user to preset desired heights.

Sun-Control Screening with Microban - The black SunTex 80 woven mesh gives the ShoreScreen a subdued shadowy effect. It absorbs and dissipates up to 80 % of the sun's heat while allowing air flow. The microban technology prevents mildew build-up when rolled up.



Convenient Wireless Operation - Simply push a button on the remote and the cover quickly raises and lowers over your boat. You can even use the same remote for both your lift and ShoreScreen.

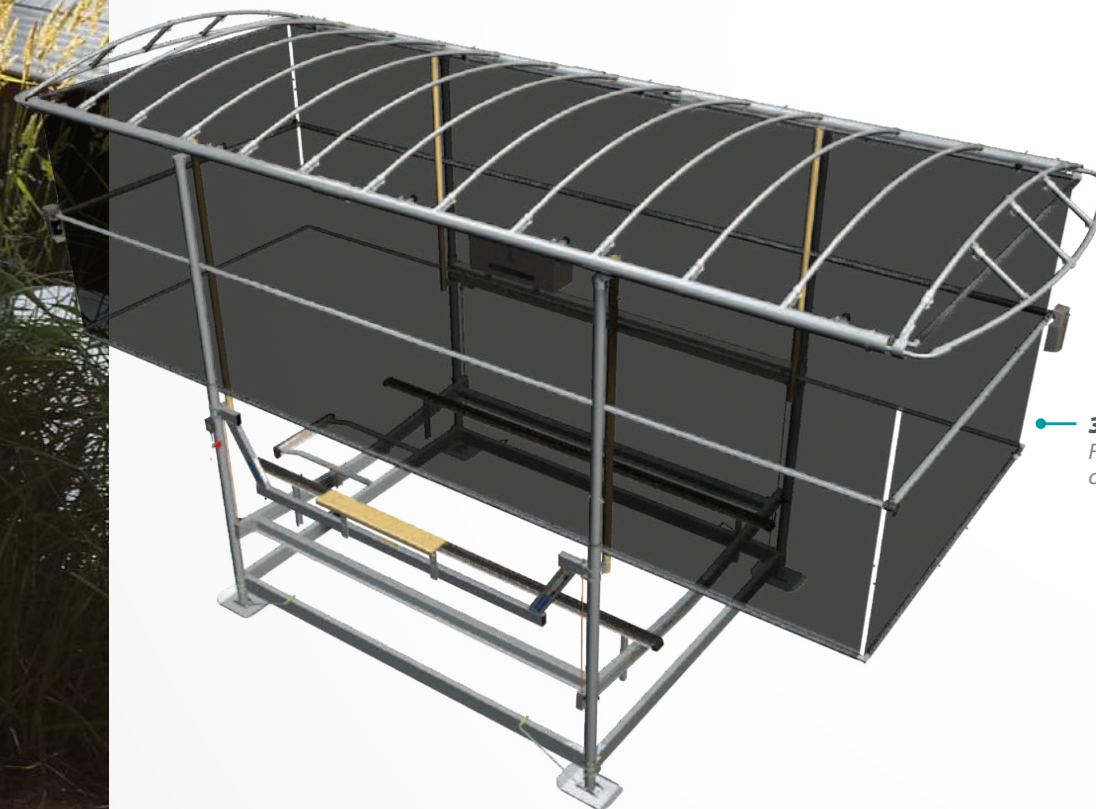

360° Protection
Fully unrolled, the curtain is 7 ft long.

ShoreStation Vinyl Covers

Protect your boat with a Genuine ShoreStation Canopy Cover. Our standard covers feature a vinyl-coated nylon fabric, superior construction with heat-welded seams.

Available in a variety of sizes to fit most ShoreStation Lifts.

Quality Control - Our canopy construction process features a computer-controlled cutting table, precision heat-welder, multiple inspections, and a dedicated staff to ensure a quality product.

Top-Quality Material and Construction - Our vinyl material consists of heavy-duty 18 oz material with 22 oz reinforced bungee pockets to prevent tear outs. Our refined sewing process entails double-stitched ends and welded seams for a watertight seal and maximum life.

Protection and Convenience - Our proprietary canopy design hangs free, maximizing entry and exit clearance. Weighted ends reduce wind damage for long canopy life.

Superior Design - Our SpoolSnap design eliminates the troublesome springs and replaces them with our large radius spools for easy removal and maximum bungee life.

Adjustability for the perfect fit - Unique adjustable frame end and post height assure a perfect canopy fit. The bolt-together frame design permits parts replacement in the event of a storm.



Vinyl Canopy Cover Color Options



Ours vs. Theirs

The SpoolSnap system features a new canopy design with a bungee cord sewn into the canopy. This bungee is simply looped over a set of spools on the canopy frame for a snug fit and easy removal.

The SpoolSnap system is now standard on all ShoreStation canopy covers. Visit your dealer today for a demonstration.

Canopy Lighting

LED Flexible Strip Canopy Light Kit - Two 60 inch, super bright, 12V light strips mounted under the lift canopy for safety at night.



AC Battery Charger

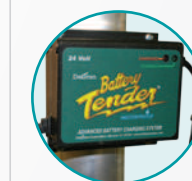

Battery Tender® - Take the hassle out of battery maintenance. Simply plug it in, connect to battery, and leave it! It quickly charges the battery using 110V power and then switches to maintenance mode to protect the battery and maintain a charge. You'll never have to worry about a dead battery - it's equivalent to never unplugging your cell phone.

Safely guide your boat into position with advanced boat protection



Boat Stops

Bring your boat to a stop in the perfect position every time. These bow and motor stops will help prevent your boat from overrunning the lift. Available in a variety of sizes to fit your boat.

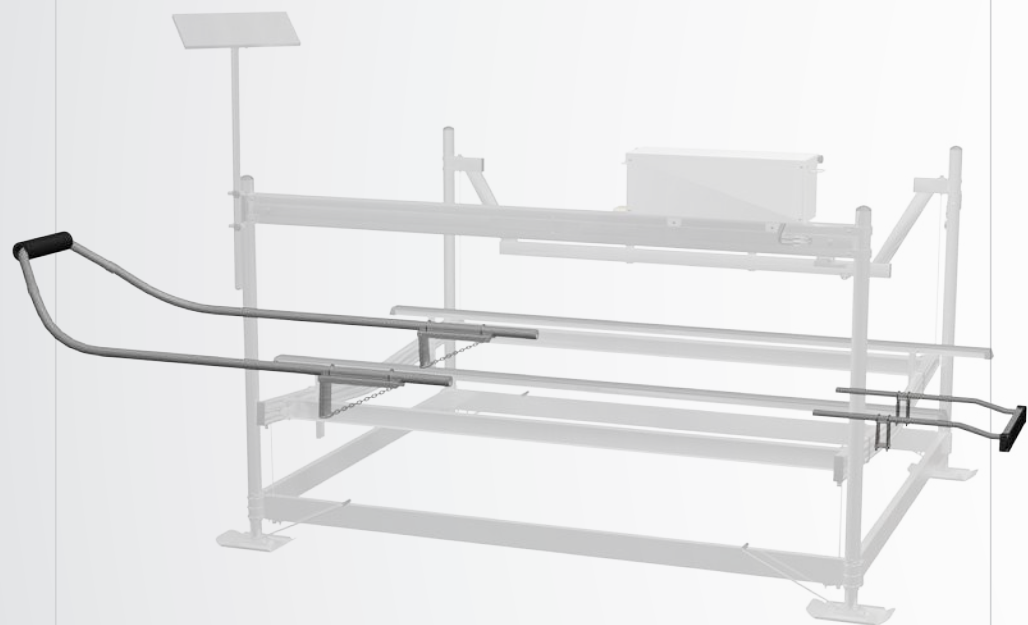

Boat Guides

Guide your boat properly into positioning with boat load guides. Our fully adjustable, low maintenance, poly covered guides provide maximum protection for your boat and lift.

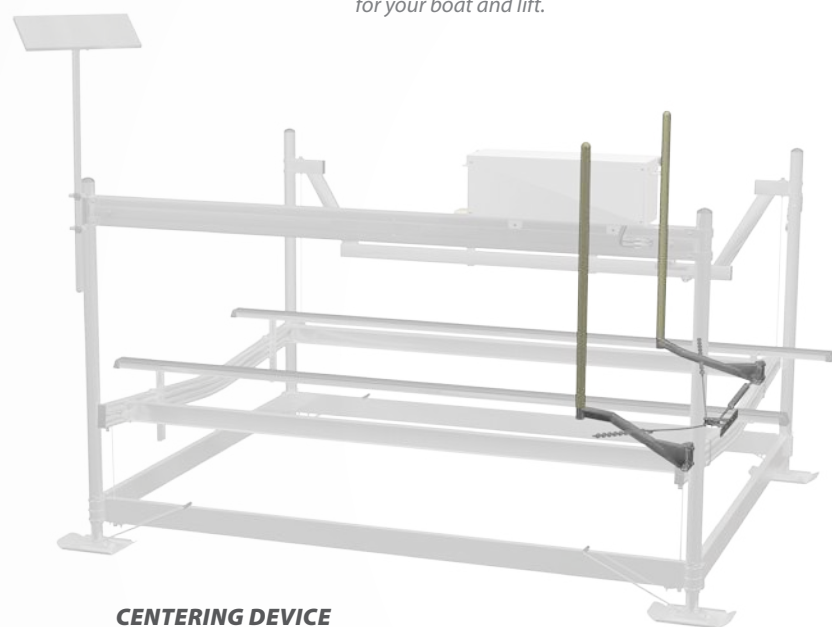

CENTERING DEVICE

These new guide posts self-adjust as the boat enters the lift to keep the boat centered for trouble-free loading every time.

Available in sand beige.

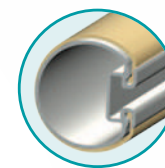

NEW! GlideRail/GlidePole CONSTRUCTION

Quickly adjusts for various boat hulls and water depths with the NEW t-slot design. The durable aluminum core with non-marring UV stable poly sheath are sure to protect your boat while absorbing repeated shocks. Available in sand beige.

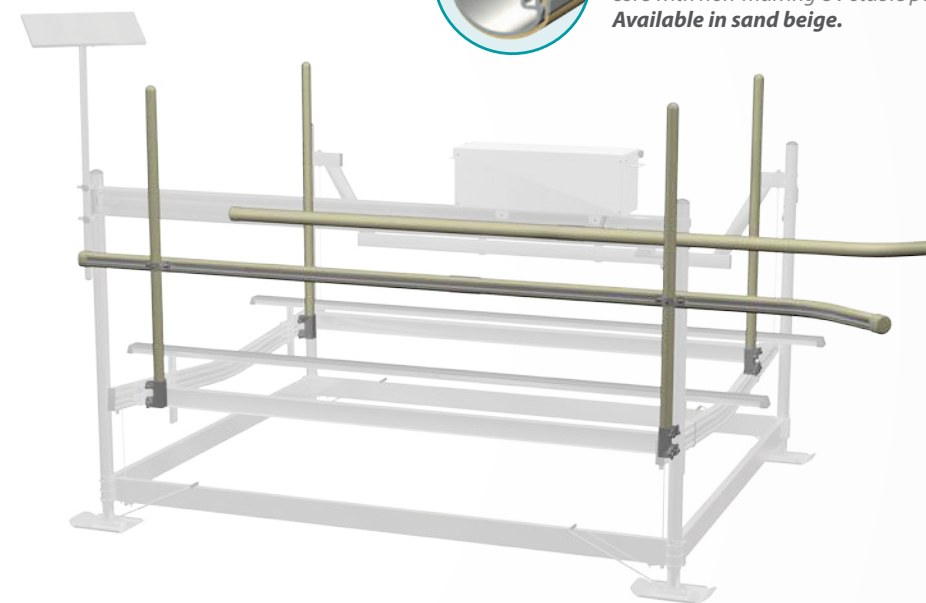

HORIZONTAL LOAD GUIDES

Unique extended flare design allows for easy entrance into your lift in wind and waves. Fully adjust horizontally and vertically for a perfect fit. Available in 3 lengths for lifts 2000 lb. to 15,000 lb. The optional non-skid boarding step provides safety when accessing your boat.

Available in sand beige.

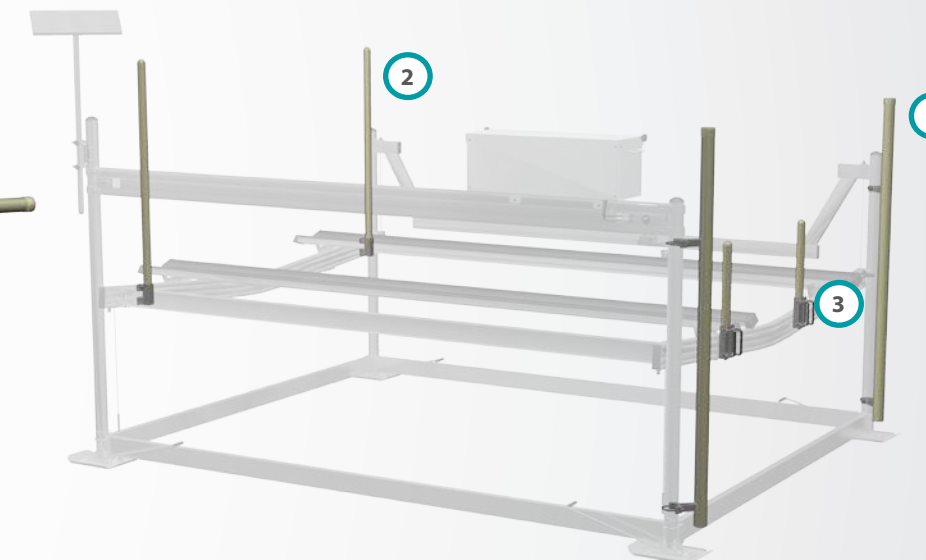

POST LOAD GUIDES

- 1 **GlidePole** – Pivots on the corner of your lift to provide a visual aid when centering and landing your boat on the lift. Fully adjustable inward, outward, and vertically for desired protection. Available in 2 lengths for 3,000 lb. to 10,000 lb. lifts.
- 2 **Front Post Load guides** – Keeps the boat's bow centered when landing in high wind or waves. Mounts on the front cradle tube to provide full adjustability for a perfect fit.
- 3 **Post Load Guides for Tritoons** – No need to sacrifice lift width when adding load guides for Tritoons. These short 23" high poly-covered posts are installed on the lift under the Tritoon deck, inside the outer tubes.



SHORESTATION LIFT SPECIFICATIONS

Models and specifications are subject to change. Recommended carrying capacity is based on the shipping weight of the boat lift with standard equipment. Adding optional equipment may decrease the boat lift's carrying capacity. Your ShoreStation dealer can recommend the specific model that meets your needs.

DECODING SHORESTATION MODEL NUMBERS
 Base model numbers provide details about that lift's capacity, width and lift system

SS <small>SS = ShoreStation</small>	V <small>V = V Frame Cradle PV = Pontoon Special</small>	40 <small>40 = 4000 lbs. (in 100s of lbs.)</small>	120 <small>120 = 120 in. wide (max. beam)</small>	H <small>ED = Electric H = Hydraulic M = Manual</small>	S <small>S = Stainless Fasteners</small>
---	--	--	---	---	--

Aluminum Vertical Boat Lift Construction & Features

	Power System	Frame & Cradle	Cables	Fasteners	Bunk Construction	Controller	Boat Access	Protection	Optional Features				
									Battery Charger	Boat Support	Extension Legs	Load Guides	Boat Stops
HS	Hydraulic	Aluminum	Stainless Steel with 15 Year Warranty	Stainless/Brass	Ultra Bunk	Wireless Remote plus Dockside Up-Down Switch	Drop Side Support Bar	Top Limit Sensor	Solar or Battery Tender®	2-Bunk Standard 4-Bunk Pontoon Log Rack Pontoon Center ToolRail	Standard Deep Water Screw Adjust	GlideRail GlidePole Post Spring-Loaded ToonRail	Motor Stop Bow Stop ToonRail
EDS	Electric	Aluminum	Stainless Steel with 15 Year Warranty	Stainless/Brass	Ultra Bunk	Wireless Remote plus Dockside Up-Down Switch	Drop Side Support Bar	Top Limit Sensor Backwind Sensors	Solar or Battery Tender®				
MS	Manual	Aluminum	Stainless Steel	Stainless/Brass	Ultra Bunk	N/A	N/A	N/A	N/A				

Aluminum Vertical Lifts 2000 lb. - 6000 lb.

Base Model #	Power System	Max. Load Capacity	Inside Width Between Posts	Lift Height	Overall Width (w/base pads)	Maximum water depth with Boat out of water 24"			
						Standard Adjustable Legs	40" Extention Legs	Deep Water Models	Lift Level'r Legs
SSV20100	MS/EDS	2000 lb. (907kg)	100" (2.54m)	48" (1.22m)	9' 7" (2.92m)	4' 8" (1.42m)	6' 4" (1.93m)	7' 7" (2.31m)	5' (1.52m)
SSV30108	MS/EDS	3000 lb. (1361kg)	108" (2.74m)	48" (1.22m)	10' 3" (3.12m)	4' 8" (1.42m)	6' 4" (1.93m)	7' 7" (2.31m)	5' (1.52m)
SSV30120	MS/EDS	3000 lb. (1361kg)	120" (3.05m)	48" (1.22m)	11' 3" (3.43m)	4' 8" (1.42m)	6' 4" (1.93m)	7' 7" (2.31m)	5' (1.52m)
SSV40108	MS/EDS/HS	4000 lb. (1814kg)	108" (2.74m)	48" (1.22m)	10' 3" (3.12m)	4' 8" (1.42m)	6' 4" (1.93m)	7' 7" (2.31m)	5' (1.52m)
SSV40120	MS/EDS/HS	4000 lb. (1814kg)	120" (3.05m)	48" (1.22m)	11' 3" (3.43m)	4' 8" (1.42m)	6' 4" (1.93m)	7' 7" (2.31m)	5' (1.52m)
SSV50108	MS/EDS	5000 lb. (2268kg)	108" (2.74m)	54" (1.37m)	10' 3" (3.12m)	5' 2" (1.57m)	6' 10" (2.08m)	8' 1" (2.46m)	5' 6" (1.67m)
SSV50120	MS/EDS/HS	5000 lb. (2268kg)	120" (3.05m)	54" (1.37m)	11' 3" (3.43m)	5' 2" (1.57m)	6' 10" (2.08m)	8' 1" (2.46m)	5' 6" (1.67m)
SSV60108	EDS	6000 lb. (2722kg)	108" (2.74m)	54" (1.37m)	10' 3" (3.12m)	5' 2" (1.57m)	6' 10" (2.08m)	8' 1" (2.46m)	5' 6" (1.67m)
SSV60120	EDS/HS	6000 lb. (2722kg)	120" (3.05m)	54" (1.37m)	11' 3" (3.43m)	5' 2" (1.57m)	6' 10" (2.08m)	8' 1" (2.46m)	5' 6" (1.67m)
SSV60132	HS	6000 lb. (2722kg)	132" (3.35m)	54" (1.37m)	12' 3" (3.73m)	5' 2" (1.57m)	6' 10" (2.08m)	8' 1" (2.46m)	5' 6" (1.67m)

Specialty Pontoon Lifts

Base Model #	Max. Load Capacity	Inside Width Between Posts	Platform Length	Bunk Length	Lift Height	Overall Width (w/base pads)	Maximum water depth with Boat out of water 24"				Power Systems		
							Standard Adjustable Legs	40" Extention Legs	Deep Water Models	Lift Level'r Legs	DC Hydraulic "HS"	DC Electric "EDS"	Manual "MS"
SSPV50132L	5000 lb. (2268kg)	132" (3.35m)	13' 10" (4.21m)	15' (4.57m)	54" (1.37m)	12' 3" (3.73m)	5' 2" (1.57m)	6' 10" (2.08m)	8' 1" (2.46m)	5' 6" (1.67m)	YES	YES	YES
SSPV100144HSDW	10,000 lb. (4535kg)	144" (3.65m)	12' 10" (3.91m)	14' (4.27m)	66" (1.68m)	13' 9" (4.19m)	N/A	N/A	9' 10" (3m)	N/A	YES	NO	NO

Base models are available configured with these options: **STD**= Standard Legs **DW**= Deep Water Legs **PT**= Pontoon Supports Note : For more detailed specifications go to www.shorestation.com

Aluminum Vertical Lifts 7000 lb. - 15,000 lb.

Base Model #	Max. Load Capacity	Inside Width Between Posts	Lift Height	Overall Width (w/base pads)	Maximum water depth with Boat out of water 24"	DC 12 or 24 Volt Hydraulic
SSV70120HSDW	7000 lb. (3175kg)	120" (3.05m)	64" (1.63m)	11' 3" (3.43m)	9' 2" (2.8m)	12V
SSV70132HSDW	7000 lb. (3175kg)	132" (3.35m)	64" (1.63m)	12' 3" (3.73m)	9' 2" (2.8m)	12V
SSV80132HSDW	8000 lb. (3629kg)	132" (3.35m)	66" (1.68m)	12' 9" (3.89m)	9' 10" (3.0m)	12V
SSV100132HSDW	10000 lb. (4536kg)	132" (3.35m)	66" (1.68m)	12' 9" (3.89m)	9' 10" (3.0m)	24V
SSV100144HSDW	10000 lb. (4536kg)	144" (3.66m)	66" (1.68m)	13' 9" (4.19m)	9' 10" (3.0m)	24V
SSV150144HSDW	15000 lb. (6803kg)	144" (3.66m)	72" (1.83m)	13' 9" (4.19m)	10' 11" (3.33m)	24V

Note : For more detailed specifications go to www.shorestation.com

Aluminum Free-standing Cantilever Lifts

Base Model #	Max. Load Capacity	Inside Width Between Posts	Lift Height	Overall Width (w/base pads)	Standard Adjustable Legs	40" Extention Legs	Adjustable Legs	Weight
SSV1288-4	1200 lb. (544kg)	88" (2.24m)	42" (1.07m)	8' 3" (2.51m)	44" (1.12m)	64" (1.63m)	4	208 lb. (94.35kg)

Note : For more detailed specifications go to www.shorestation.com

PWC Free-standing Vertical Lifts

Base Model #	Construction	Single or 2-Place	Max. Load Capacity	Inside Width Between Posts	Lift Height	Lift Mechanism	Adjustable Legs	Overall Width (w/base pads)	Maximum Water Depth with PWC out of water 24"
SSV1564M	Aluminum	Single	1500 lb. (680kg)	64" (1.63m)	56" (1.42m)	Manual	4	78" (1.98m)	66" (1.68m)
SSV1564ED	Aluminum	Single	1500 lb. (680kg)	64" (1.63m)	56" (1.42m)	12V Electric	4	78" (1.98m)	66" (1.68m)

Note : For more detailed specifications go to www.shorestation.com

PWC Free-standing Cantilever Lifts

Base Model #	Construction	Single or 2-Place	Max. Load Capacity	Inside Width Between Posts	Lift Height	Lift Mechanism	Adjustable Legs	Overall Width (w/base pads)	Maximum Water Depth with PWC out of water 24"
SS853	Steel	Single	800 lb. (363kg)	53" (1.35m)	42" (1.07m)	Manual	2	64" (1.63m)	24" (61m)
SS8531	Steel	Single	800 lb. (363kg)	53" (1.35m)	42" (1.07m)	Manual	4	64" (1.63m)	40" (1.02m)
SS1062	Aluminum	Single	1000 lb. (454kg)	62" (1.57m)	42" (1.07m)	Manual	2	76" (1.93m)	24" (61m)
SS10621	Aluminum	Single	1000 lb. (454kg)	62" (1.57m)	42" (1.07m)	Manual	4	76" (1.93m)	44" (1.18m)
SS10621ED	Aluminum	Single	1000 lb. (454kg)	62" (1.57m)	42" (1.07m)	12V Electric	4	76" (1.93m)	44" (1.18m)
SSD10521	Aluminum	2-Place	1000 lb. ea. (454kg)	52" (1.32m)	42" (1.07m)	Manual	4	122" (3.10m)	44" (1.18m)
SSD10521ED	Aluminum	2-Place	1000 lb. ea. (454kg)	52" (1.32m)	42" (1.07m)	12V Electric	4	122" (3.10m)	44" (1.18m)

Note : For more detailed specifications go to www.shorestation.com

PWC Dock Mount Lifts

Base Model #	Construction	Dock Type Mount Systems	Lift Mechanism	Winch Post Height	Max. Load Capacity	Inside Width	Lift Height	Adjustable Legs	Standard Adjustable Legs	40" Extention Legs
SS1053M	Aluminum	ShoreBridge, Classic, & Universal	Manual	7' (2.13m)	1000 lb. (454kg)	53" (1.35m)	48" (1.22m)	1	4' (1.47m)	6' 8" (2.03m)
SS1053ED	Aluminum	ShoreBridge, Classic, & Universal	12V Electric	10' (3.05m)	1000 lb. (454kg)	53" (1.35m)	48" (1.22m)	1	4' (1.47m)	6' 8" (2.03m)

Note : For more detailed specifications go to www.shorestation.com



Your Summer.
Simplified.
ShoreStation®

Share Your Summer Story.

Visit ShoreStationSimple.com for more details!

Summer. If you live on the water, there's no doubt it's the best season of the year. Whether your memories are made from the boat or the dock, the water or the land, this is the time where your stories are written. ShoreStation is proud to help make those moments happen, and this year, by simply sharing your summer story with us, you could WIN big.

▶▶ AUTHORIZED DEALER

ShoreStation® | *At the forefront of shorefront since 1959*

Manufactured by Midwest Industries, Inc.
122 E. State Hwy 175
Ida Grove, Iowa 51445-1140
1.800.859.3028
shorestation.com

A1611283 16-0473
Revised 11/16